	<b>2<sup>nd</sup> Generation Refrigerated Air Dryer</b>		Rev.	Date	Prepared By	Checked By	Approved By
			1	2020.09.18	WOO.I.H.	JO.S.J.	KIM.H.W.
	<b>Air Cooled Type</b>		2				
			3				
4							
Project Name			-		Model Name		HYD-7N2
<b>SPECIFICATION</b>							
1							
2	Supply Voltage	220V	Inlet Flow Rate	0.8	Nm3/min		
3	Phase	1PH	Inlet Pressure	7	barg		
4	Frequency	60Hz	Inlet Temp.	38	°C		
5	Control use	220V	Outlet Flow Rate	0.8	Nm3/min		
6	Fulid	Compressed Air	Outlet Pressure	6.8	barg		
7	Location	Indoor	Outlet Temp.	28±5	°C		
8	Design Code	Maker STD.	Pressure Drop	0.2	bar		
9	Area Class	Non-Hazardous	Outlet Dew Point	2~10	°C		
10			Design Pressure	14	barg		
11			Design Temperature	70	°C		
12			Ambient Temperature	32	°C		
<b>CONSTRUCTION</b>							
13							
14	Refrigerant	R-134A	Dimension (W x L x H)	244 X 554 X 754	mm		
15	Ref. Compressor Type	Recipro Hemertic	Weight	36	kg		
16	Ref. Compressor Capacity	1/5 HP	Min. Power Consumption	0.15	kW		
17	Condenser Type	Air Cooled	Inlet Connection	15A	PT Female Screw		
18	Condenser Fan Motor	9 W	Outlet Connection	15A	PT Female Screw		
19		1 EA	Drain Connection	10A	PT Female Screw		
20	Condenser Fan Size	230 mm	Color (Munsell)	5.7PB 4.1/9.9			
21	Condenser Capacity	1/4 HP		5.7PB 2.9/3.5			
22	Condenser Material	Aluminum & Copper					
23	Heat Exchanger Type	Block					
24	Heat Exchanger Material	Aluminum					
25	Ref. Control Device	Capillary Tube					
26	ECO Mode Control	Dew Point Temp. Control					
27	Drain Trap Type	Auto Float					
<b>STANDRAD FEATURES AND CONTROL</b>							
28							
29	Fan Controller	YES	Ref. Compressor	YES			
30	Ref. Liquid Filter Dryer	YES	Capillary Tube	YES			
31	Overload Relay	NO	Hot Gas Bypass Valve	NO			
32	PCB Controller	YES	Air Cooled Condenser	YES			
33	Fan Motor Test Button	NO	Accumulator	NO			
34	Air Pressure Gauge	NO	Liquid Ref. Receiver	NO			
35	Ref. Pressure Gauge	NO	Oil Separator	NO			
36	High Pressure Switch	NO	Circuit Breaker	NO			
37	Moisture Indicator	NO	Ref. Compressor Heater	NO			
38	Drain	YES					
<b>NOTES</b>							
39							
40							
41							
42							
43							
44							
45							
46							

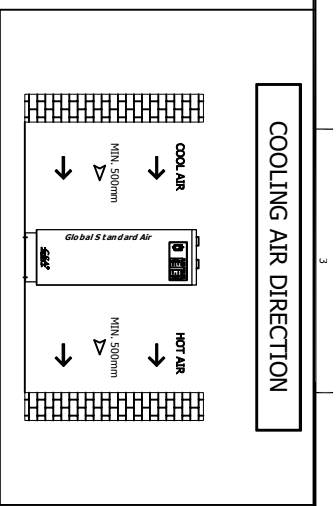

SPECIFICATION	
INLET AIR TEMPERATURE	38°C
AMBIENT TEMPERATURE	32°C
INLET AIR PRESSURE	7 barg
CAPACITY	0.8 Nm <sup>3</sup> /min
IN/OUT CONNECTION	PT 15A
DIMENSION(WXDxH, mm)	244 X 554 X 754
WEIGHT	36 kg
MIN. POWER CONSUMPTION	0.15 kW
POWER SUPPLY	220V - 1PH - 50/60Hz

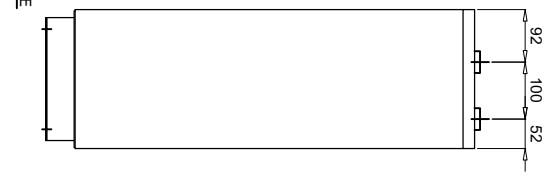

REV.	NO.	DATE	DESCRIPTION	CHK.	APP.	DATE	APP.
Δ	1	2010.09.16	ISSUED FOR REFERENCE				
Δ	2						
Δ	3						
Δ	4						
Δ	5						

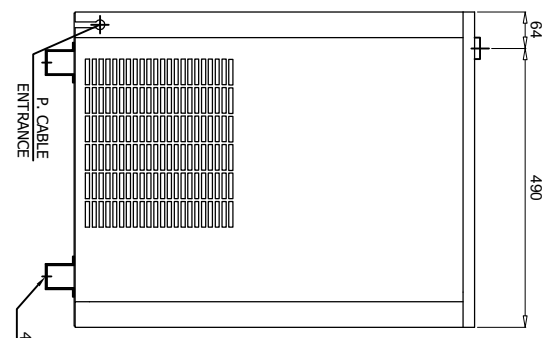
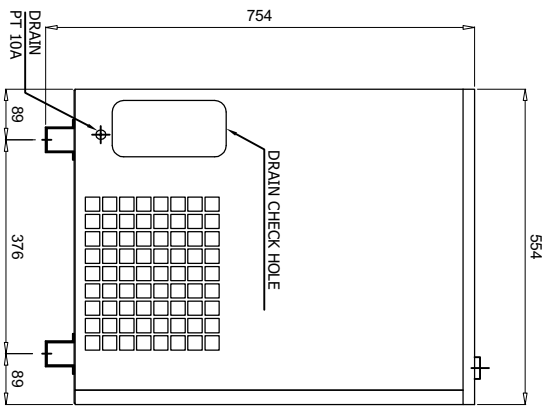
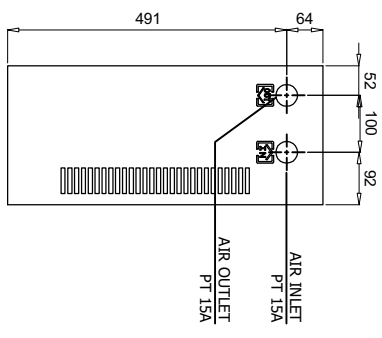

OUTLINE DRAWING

TITLE	OUTLINE DRAWING	
ITEM NO.	HYD/2N	PART NO.
SCALE	NONE	GSA-HHD-0007N2-01
REV.	Δ	

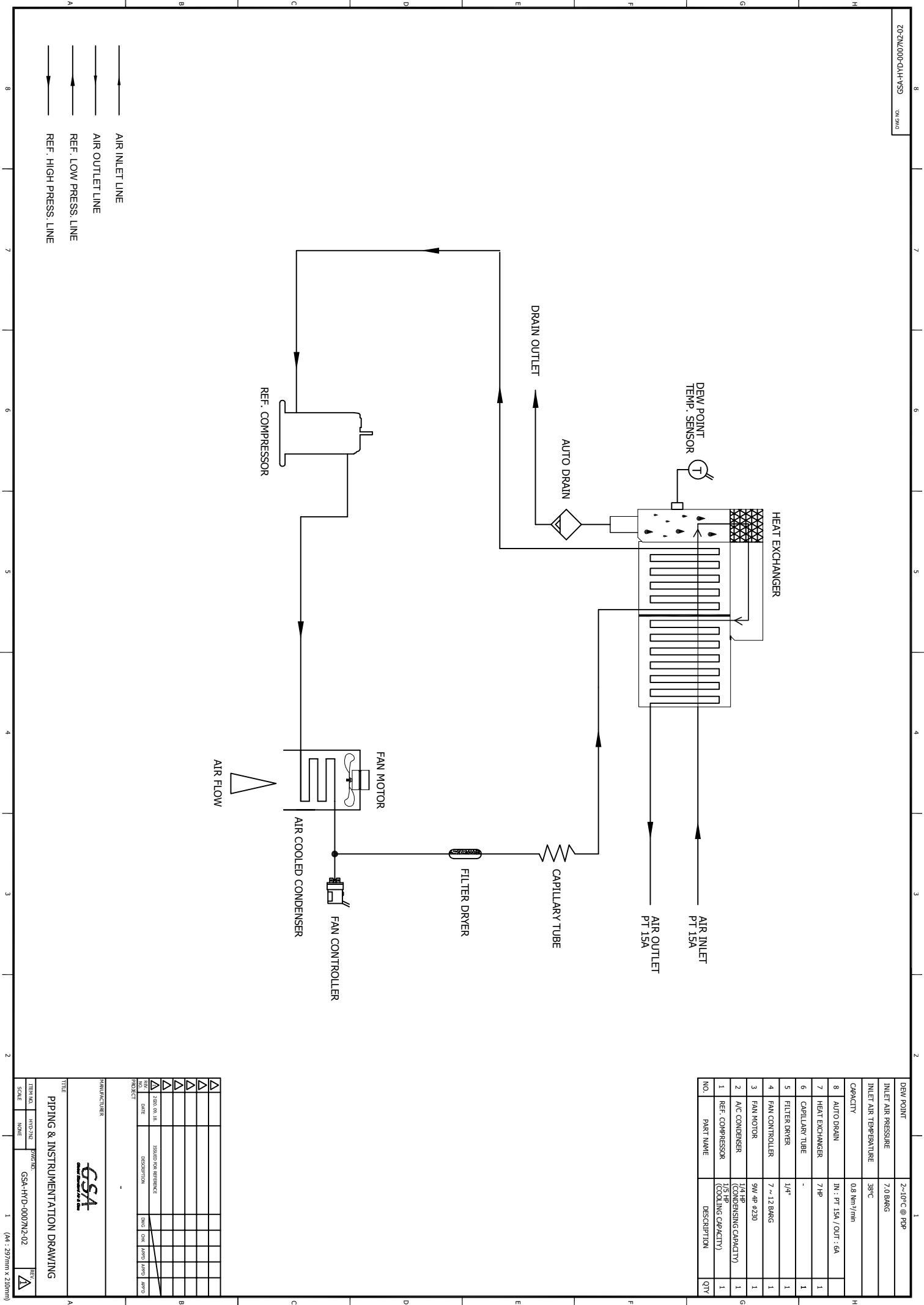

NO.	PART NAME	DESCRIPTION	QTY
	DEW POINT	2~10°C @ 1PP	1
	INLET AIR PRESSURE	7.0 BARG	
	INLET AIR TEMPERATURE	38°C	
	CAPACITY	0.8 Nm <sup>3</sup> /min	
8	AUTO DRAIN	IN : PT 15A / OUT : 6A	1
7	HEAT EXCHANGER	7 HP	1
6	CAPILLARY TUBE	-	1
5	FILTER DRYER	1/4"	1
4	FAN CONTROLLER	7 ~ 12 BARG	1
3	FAN MOTOR	9W 4P #230	1
2	A/C CONDENSER	FAN COOLING CAPACITY	1
1	REF. COMPRESSOR	1/5 HP (COOLING CAPACITY)	1

REV.	DATE	DESCRIPTION	CHK.	APP.	DATE
Δ					
Δ					
Δ					
Δ					
Δ					
Δ					
Δ					
Δ					
Δ					
Δ					

MANUFACTURER

**GSA**  
GSA GROUP OF COMPANIES

TITLE  
**PIPING & INSTRUMENTATION DRAWING**

ITEM NO.	HYD/INSTR	PART NO.	REV.
SCALE	NONE	GSA-HHD-000N12-02	Δ

(44 : 297mm x 210mm)

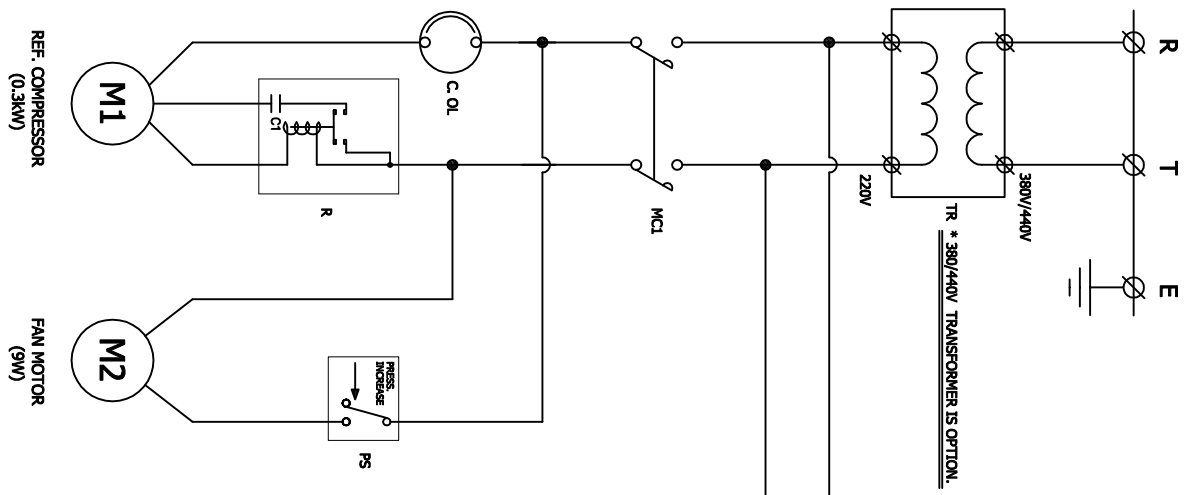

NO.	SYMBOL	DESCRIPTION
POWER SOURCE AC 220V, 1ph, 50/60Hz		
10	SW1	DRYER ON/OFF SWITCH
9	TR	TRANSFORMER
8	TS1	DEW POINT TEMP. SENSOR
7	PS	FAN CONTROLLER
6	C. OL	REF. COMPRESSOR OVERLOAD
5	CI	STARTING CAPACTOR
4	R	RELAY
3	MCI	MAGNETIC CONTACTOR
2	M2	FAN MOTOR
1	M1	REF. COMPRESSOR

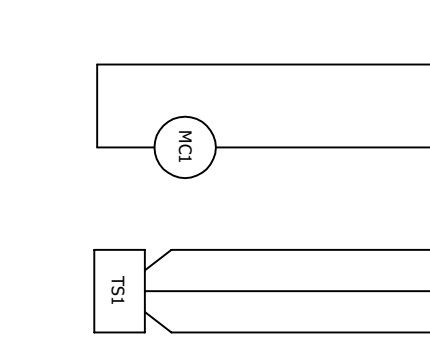
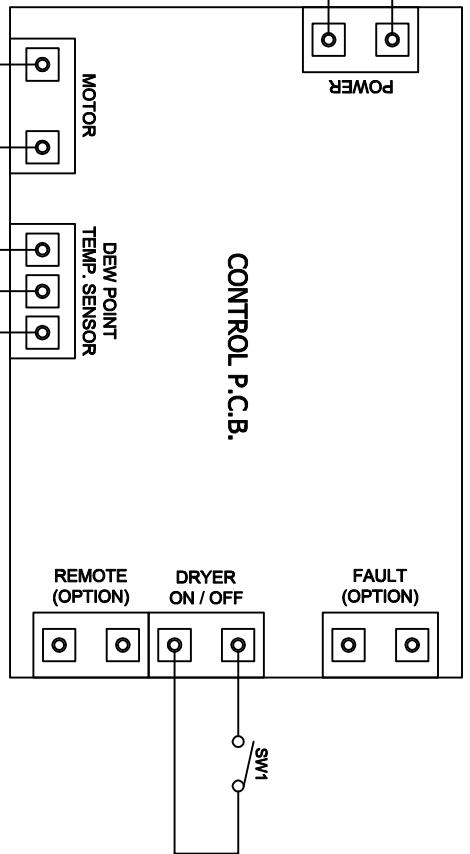

REV. NO.	DATE	REVISION	CHK.	APP.	DATE	APP.
1		ISSUED FOR REFERENCE				
2		2008.06.18.				
3						
4						
5						
6						
7						
8						

MANUFACTURER: **GSA**  
**WIRING DRAWING**  
 TITLE: WIRING DRAWING  
 DRAWING NO.: GSA-HFD-000N2-03  
 SCALE: NONE  
 (44' x 297mm x 210mm)