	Refrigerated Air Dryer		Rev.	Date	Prepared By	Checked By	Approved By
			1	2019.01.15	LEE.S.M.	JO.S.J.	KIM.H.W.
	Air Cooled Type		2				
			3				
			4				
Project Name		-	Model Name		HYD-250N		
SPECIFICATION							
2	Supply Voltage	380V	Inlet Flow Rate	39	Nm ³ /min		
3	Phase	3PH	Inlet Pressure	7	barg		
4	Frequency	60Hz	Inlet Temp.	38	°C		
5	Control use	220V	Outlet Flow Rate	39	Nm ³ /min		
6	Fulid	Compressed Air	Outlet Pressure	6.8	barg		
7	Location	Indoor	Outlet Temp.	28±5	°C		
8	Design Code	Maker STD.	Pressure Drop	0.2	bar		
9	Area Class	Non-Hazardous	Outlet Dew Point	2~10	°C		
10			Design Pressure	9.7	barg		
11			Design Temperature	70	°C		
12			Ambient Temperature	32	°C		
CONSTRUCTION							
14	Refrigerant	R-22	Dimension (W x L x H)	700 X 1,200 X 1,580	mm		
15	Ref. Compressor Type	Scroll	Weight	260	kg		
16	Ref. Compressor Capacity	5 HP	Power Consumption	4.38	kW		
17	Condenser Type	Air Cooled	Inlet Connection	100A	KS 10K SO.FF.		
18	Condenser Fan Motor	0.4 kW	Outlet Connection	100A	KS 10K SO.FF.		
19		1 EA	Drain Connection	15A	PT Female Screw		
20	Condenser Fan Size	600 mm	Color (Munsell)	5.7PB 4.1/9.9			
21	Condenser Capacity	5 HP		5.7PB 2.9/3.5			
22	Condenser Material	Aluminum & Copper					
23	Heat Exchanger Type	Block					
24	Heat Exchanger Material	Aluminum					
25	Ref. Control Device	TEV					
26	Temp. Control Device	Hot Gas Bypass Valve					
27	Drain Trap Type	Level Sensor					
STANDRAD FEATURES AND CONTROL							
29	Ref. Pressure Transmitter	YES	Ref. Compressor	YES			
30	Ref. Liquid Filter Dryer	YES	Expansion Valve	YES			
31	Overload Relay	YES	Hot Gas Bypass Valve	YES			
32	PCB Controller	YES	Air Cooled Condenser	YES			
33	4.3" TFT LCD	YES	Accumulator	YES			
34	Air Pressure Gauge	YES	Liquid Ref. Receiver	YES			
35	Ref. Pressure Gauge	YES	Oil Separator	NO			
36	Dual Pressure Switch	NO	Circuit Breaker	YES			
37	Moisture Indicator	YES	Ref. Compressor Heater	YES			
38	Drain	YES					
NOTES							
40							
41							
42							
43							
44							
45							
46							

T0-N0520-QAH-VSD
CON DWG

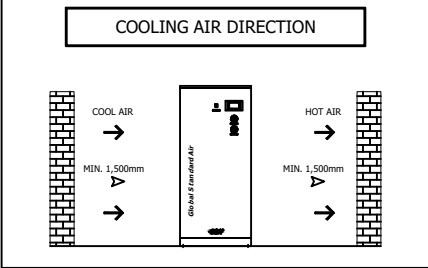

SPECIFICATION	
INLET AIR TEMPERATURE	38°C
AMBIENT TEMPERATURE	32°C
INLET AIR PRESSURE	7 barg
CAPACITY	39.0 Nm ³ /min
IN/OUT CONNECTION	100A KS 10K SO.FF.
DIMENSION(WXDXH, mm)	700 X 1,200 X 1,580
WEIGHT	260 kg
POWER CONSUMPTION	4.38 kW
POWER SUPPLY	380/440V - 3PH - 50/60Hz

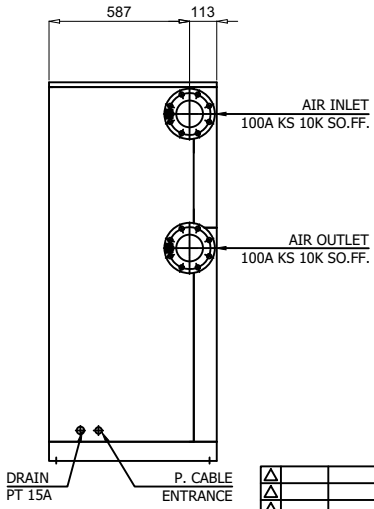
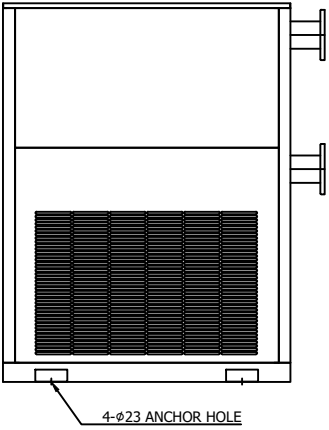
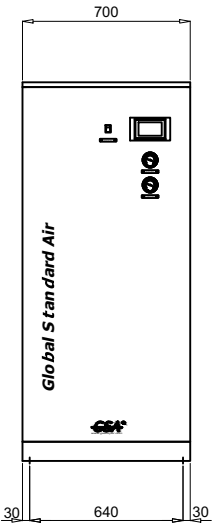
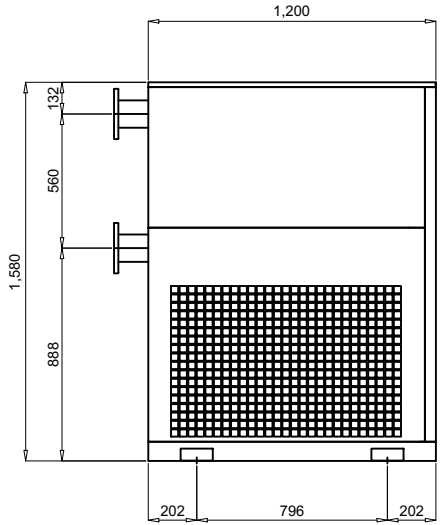
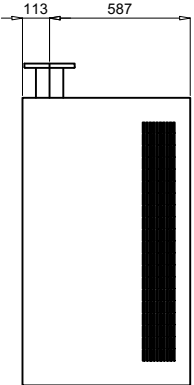

△											
△											
△											
△											
△	2018. 11. 26	ISSUED FOR REFERENCE									
REV.	DATE	DESCRIPTION	ENG	CHK	APPD	APPD					
PROJECT											
MANUFACTURER											
TITLE											
OUTLINE DRAWING											
ITEM NO.	HYD-250N	DWG NO.	GSA-HYD-0250N-01								
SCALE	NONE										

Z0-N0520-QAH-V55 (ON DWG)

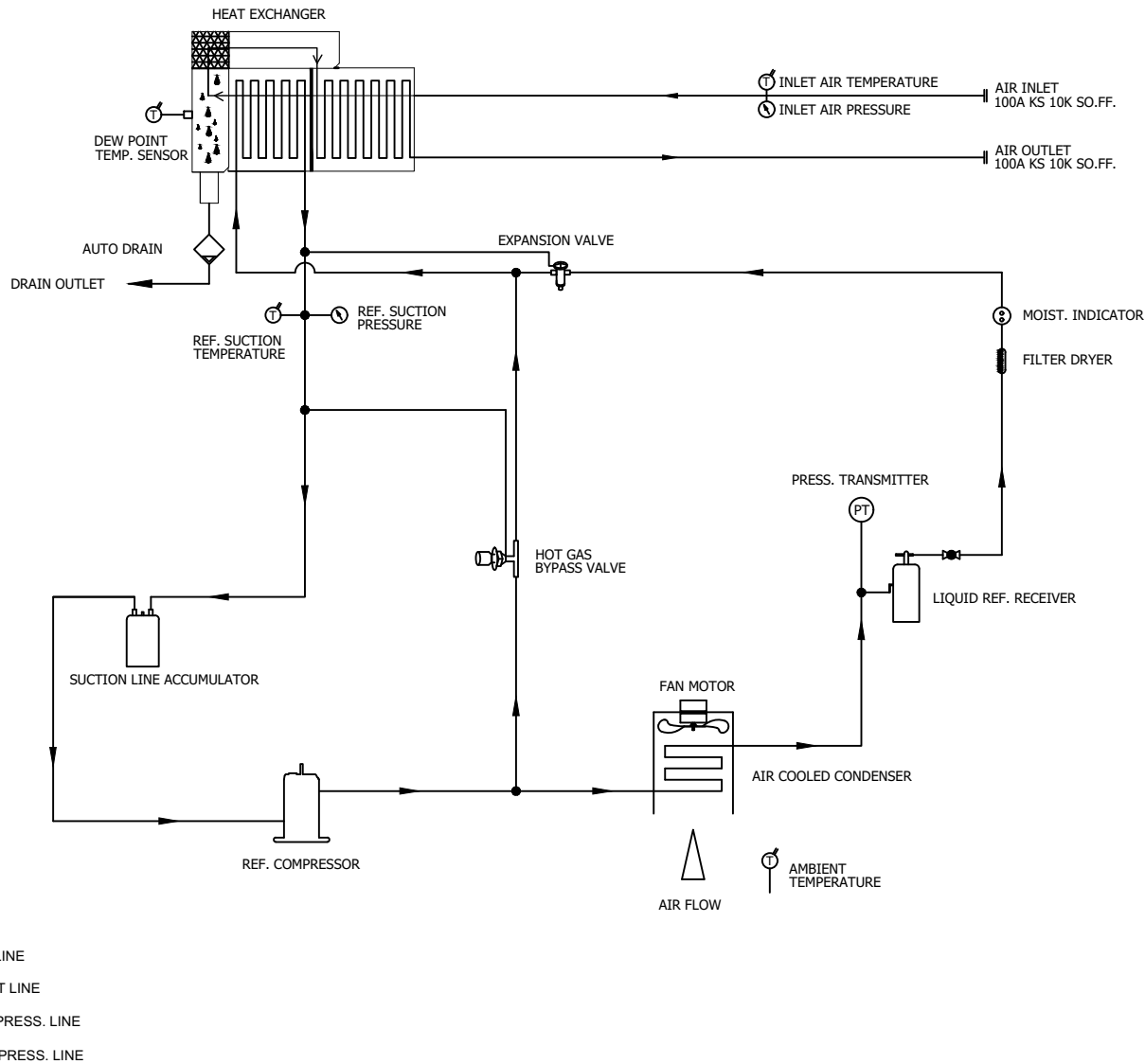

DEW POINT	2~10°C @ FDP		
INLET AIR PRESSURE	7.0 BARG		
INLET AIR TEMPERATURE	38°		
CAPACITY	39.0 Nm³/min		
14	PRESS. GAUGE	INLET AIR	1
13	PRESS. GAUGE	REF. SUCTION	1
12	AUTO DRAIN	PT 15A	1
11	HGBV	-	1
10	ACCUMULATOR	-	1
9	HEAT EXCHANGER	300 HP	1
8	EXPANSION VALVE	5 TON	1
7	MOIST. INDICATOR	1/2"	1
6	FILTER DRYER	1/2"	1
5	REF. RECEIVER	-	1
4	PRESS. TRANSMIT.	-1 ~ 35 BAR	1
3	FAN MOTOR	0.4KW 6P #600	1
2	A/C CONDENSER	5 HP (CONDENSING CAPACITY)	1
1	REF. COMPRESSOR	5 HP (COOLING CAPACITY)	1
NO.	PART NAME	DESCRIPTION	QTY

REV.	DATE	DESCRIPTION	DWG	CHK	APPD	APPD

PROJECT: -

MANUFACTURER:
GSA
Global Standard Air & Gas

TITLE:
PIPING & INSTRUMENTATION DRAWING

ITEM NO. 1412-2501 DWG NO. GSA-HYD-0250N-02
SCALE NONE (A4 : 297mm x 210mm)

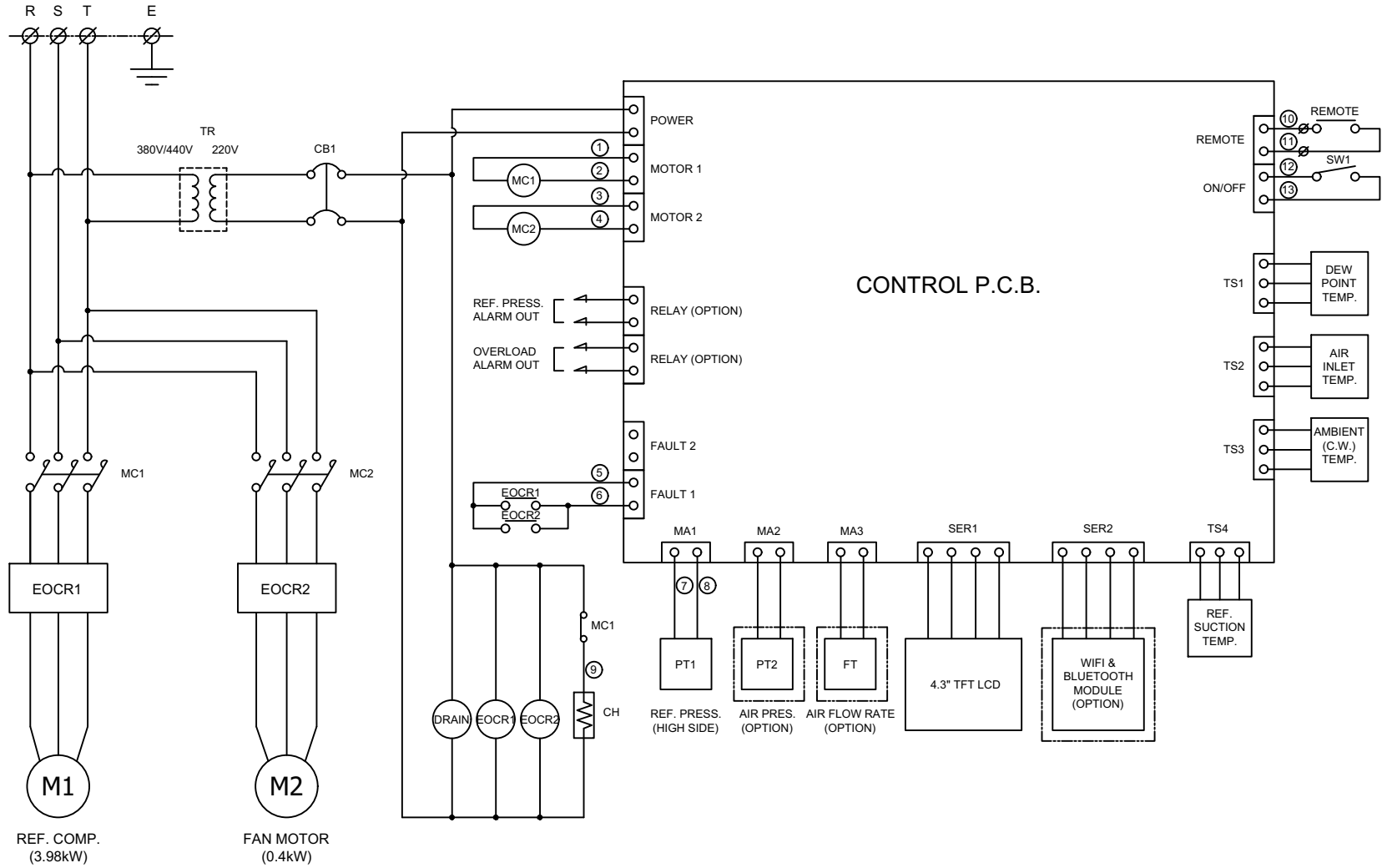

POWER SOURCE
AC 380/440V, 3Ph, 50/60Hz

11	PT1	REF. PRESSURE TRANSMITTER
10	TR	TRANSFORMER
9	SW1	SYSTEM ON/OFF SWITCH
8	CH	REF. COMP. HEATER
7	DRAIN	AUTO DRAIN VALVE
6	TS1 ~ TS4	TEMP. SENSOR
5	CB1	CIRCUIT BREAKER(CTRL)
4	MC1, MC2	MAGNETIC CONTACTOR
3	EOCR1, EOCR2	OVERLOAD RELAY
2	M2	FAN MOTOR
1	M1	REF. COMPRESSOR
NO.	SYMBOL	DESCRIPTION

***REVERSE PHASE WARNING**

Be sure to check the rotation direction of the fan motor and the operating condition of the refrigerant compressor.

- The fan motor must rotate clockwise.
- When the refrigerant compressor is operating, the refrigerant suction pressure will be lowered.

When operating in reverse phase, the refrigerant compressor is damaged.

In case of reverse phase, change the position of 2 wires out of 3 wires of the power supply line.

Problems caused by incorrect power connection are not guaranteed.

△									
△									
△									
△									
△									
△	2018. 11. 26.	ISSUED FOR REFERENCE							
REV. NO.	DATE	DESCRIPTION	DWG	CHK	APPD	APPD	APPD	APPD	APPD

PROJECT: _____

MANUFACTURER: **GSA**
Global Service Automation & Control

TITLE: **WIRING DRAWING**

ITEM NO.	HYD-250N	DWG NO.	GSA-HYD-0250N-03	REV.	△
SCALE	NONE				

(A4 : 297mm x 210mm)