	Eco Pro Refrigerated Air Dryer		Rev.	Date	Prepared By	Checked By	Approved By
			1	2020.09.18	WOO.I.H	JO.S.J.	KIM.H.W.
	Air Cooled Type		2				
			3				
4							
Project Name			-		Model Name		HYD-20N2
SPECIFICATION							
1							
2	Supply Voltage	220V	Inlet Flow Rate	2.6	Nm3/min		
3	Phase	1PH	Inlet Pressure	7	barg		
4	Frequency	60Hz	Inlet Temp.	38	°C		
5	Control use	220V	Outlet Flow Rate	2.6	Nm3/min		
6	Fulid	Compressed Air	Outlet Pressure	6.8	barg		
7	Location	Indoor	Outlet Temp.	28±5	°C		
8	Design Code	Maker STD.	Pressure Drop	0.2	barg		
9	Area Class	Non-Hazardous	Outlet Dew Point	2~10	°C		
10			Design Pressure	14	barg		
11			Design Temperature	70	°C		
12			Ambient Temperature	32	°C		
CONSTRUCTION							
13							
14	Refrigerant	R-134A	Dimension (W x L x H)	427 X 507 X 709	mm		
15	Ref. Compressor Type	Recipro Hemertic	Weight	45	kg		
16	Ref. Compressor Capacity	3/8 HP	Min. Power Consumption	0.28	kW		
17	Condenser Type	Air Cooled	Inlet Connection	25A	PT Female Screw		
18	Condenser Fan Motor	9 W	Outlet Connection	25A	PT Female Screw		
19		1 EA	Drain Connection	10A	PT Female Screw		
20	Condenser Fan Size	230 mm	Color (Munsell)	5.7PB 4.1/9.9			
21	Condenser Capacity	1/3 HP		5.7PB 2.9/3.5			
22	Condenser Material	Aluminum & Copper					
23	Heat Exchanger Type	Block					
24	Heat Exchanger Material	Aluminum					
25	Ref. Control Device	Capillary Tube					
26	ECO Mode Control	Dew Point Temp. Control					
27	Drain Trap Type	Auto Float					
STANDRAD FEATURES AND CONTROL							
28							
29	Fan Controller	YES	Ref. Compressor	YES			
30	Ref. Liquid Filter Dryer	YES	Capillary Tube	YES			
31	Overload Relay	NO	Hot Gas Bypass Valve	NO			
32	PCB Controller	YES	Air Cooled Condenser	YES			
33	Fan Motor Test Button	NO	Accumulator	NO			
34	Air Pressure Gauge	NO	Liquid Ref. Receiver	NO			
35	Ref. Pressure Gauge	NO	Oil Separator	NO			
36	High Pressure Switch	NO	Circuit Breaker	NO			
37	Moisture Indicator	NO	Ref. Compressor Heater	NO			
38	Drain	YES					
NOTES							
39							
40							
41							
42							
43							
44							
45							
46							

T0-ZN0Z00-GJH-VSS
CON DWG

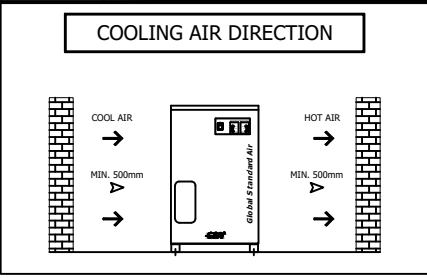

SPECIFICATION	
INLET AIR TEMPERATURE	38°C
AMBIENT TEMPERATURE	32°C
INLET AIR PRESSURE	7 barg
CAPACITY	2.6 Nm ³ /min
IN/OUT CONNECTION	PT 25A
DIMENSION(WXDXH, mm)	427 X 507 X 709
WEIGHT	45 kg
MIN. POWER CONSUMPTION	0.28 kW
POWER SUPPLY	220V - 1PH - 50/60Hz

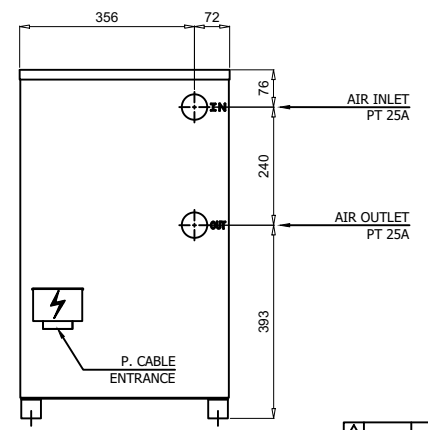
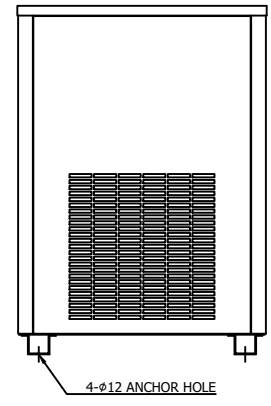
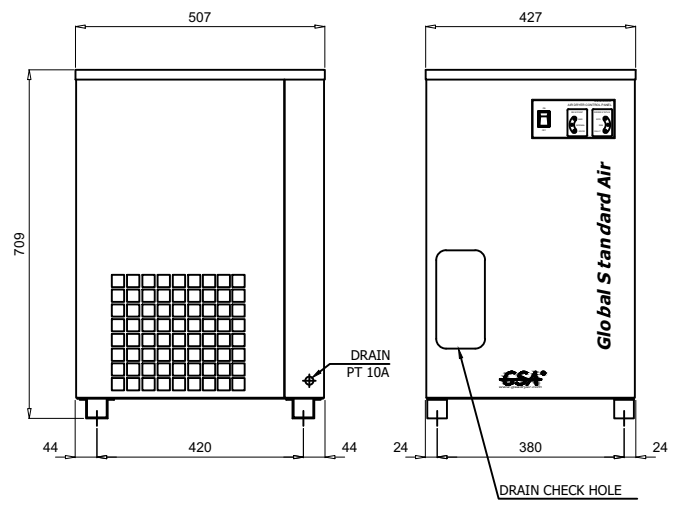
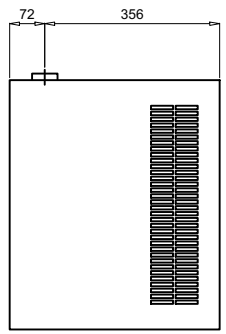

REV.	DATE	DESCRIPTION	DWG	CHK	APPD	APPD
2020.09.18		ISSUED FOR REFERENCE				
PROJECT						
MANUFACTURER						
GSA Global Standard Air & Gas						
TITLE						
OUTLINE DRAWING						
ITEM NO.	HYD-20N2	DWG NO.	GSA-HYD-0020N2-01			
SCALE	NONE					

(A4 : 297mm x 210mm)

Z0-N0Z00-GJH-VSS
ON DWG

DEW POINT	2~10°C @ FDP	
INLET AIR PRESSURE	7.0 BARG	
INLET AIR TEMPERATURE	38°C	
CAPACITY	2.6 Nm ³ /min	
9	HGBV	-
8	AUTO DRAIN	IN : PT 15A / OUT : 6A
7	HEAT EXCHANGER	20 HP
6	CAPILLARY TUBE	-
5	FILTER DRYER	1/4"
4	FAN CONTROLLER	7 ~ 12 BARG
3	FAN MOTOR	9W 4P ø230
2	A/C CONDENSER	1/3 HP (CONDENSING CAPACITY)
1	REF. COMPRESSOR	3/8 HP (COOLING CAPACITY)
NO.	PART NAME	DESCRIPTION

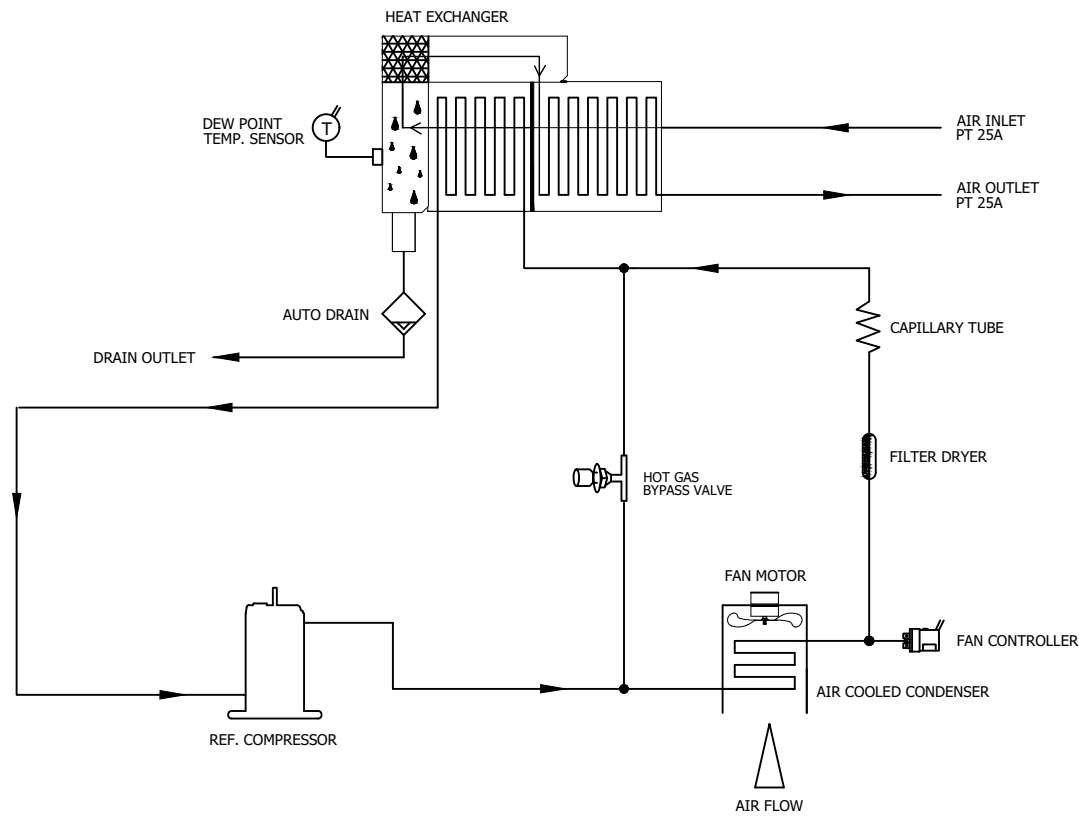

- ← AIR INLET LINE
- AIR OUTLET LINE
- ← REF. LOW PRESS. LINE
- REF. HIGH PRESS. LINE

REV.	DATE	DESCRIPTION	ENG	CHK	APPD	APPD
1	2020.09.18	ISSUED FOR REFERENCE				
PROJECT						
MANUFACTURER						
 <small>Global Standard Air & Gas</small>						
TITLE						
PIPING & INSTRUMENTATION DRAWING						
ITEM NO.	HYD-20N2	DWG NO.	GSA-HYD-0020N2-02			
SCALE	NONE					

(A4 : 297mm x 210mm)

E0-N0Z00-GJH-VSS
ON DWG

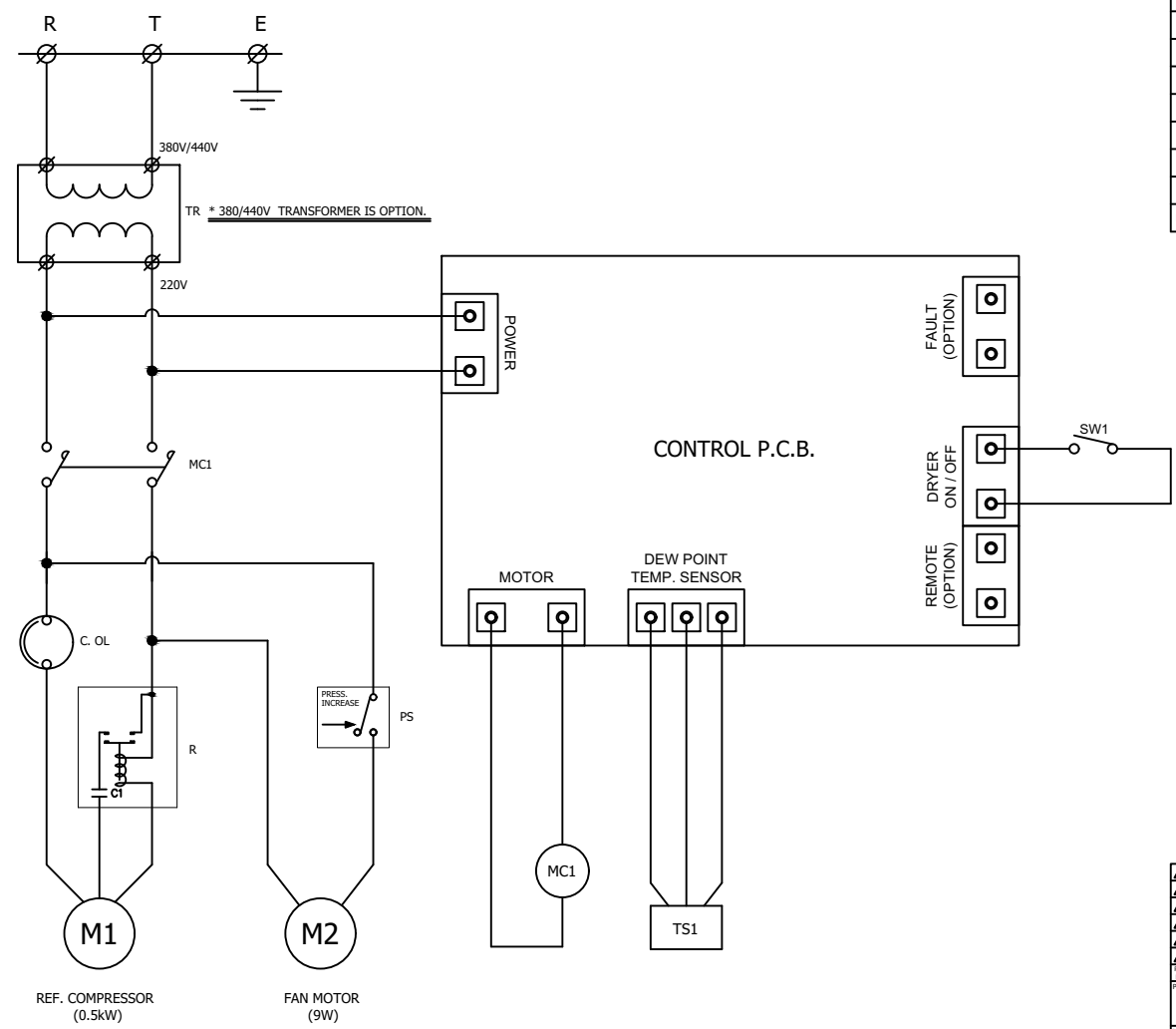

POWER SOURCE AC 220V, 1Ph, 50/60Hz		
NO.	SYMBOL	DESCRIPTION
10	SW1	DRYER ON/OFF SWITCH
9	TR	TRANSFORMER
8	TS1	DEW POINT TEMP. SENSOR
7	PS	FAN CONTROLLER
6	C. OL	REF. COMPRESSOR OVERLOAD
5	Cl	STARTING CAPACITOR
4	R	RELAY
3	MC1	MAGNETIC CONTACTOR
2	M2	FAN MOTOR
1	M1	REF. COMPRESSOR

△										
△										
△										
△										
△	2020. 09. 18.	ISSUED FOR REFERENCE								
REV.	DATE	DESCRIPTION	ENG	CHK	APPD	APPD				
PROJECT										
MANUFACTURER										
TITLE										
WIRING DRAWING										
ITEM NO.	HYD-20N2	DWG NO.	GSA-HYD-0020N2-03							REV.
SCALE	NONE								△	

(A4 : 297mm x 210mm)